



Safety Instructions

Read this manual carefully before use, and retain it for future reference.

This product is for floor cleaning in a home environment only. Do not use it outdoors, on non-floor surfaces, or in a commercial or industrial setting.

Usage Restrictions

- This appliance can be used by children aged from 8 years and above and persons with reduced physical, sensory or mental capabilities or lack of experience and knowledge if they have been given supervision or instruction concerning use of the appliance in a safe way and understand the hazards involved. Children shall not play with the appliance. Cleaning and user maintenance shall not be made by children without supervision.
- This appliance contains batteries that are only replaceable by skilled persons.
- Please keep the cleaning brush out of reach of children.
- Keep hair, loose clothing, fingers, and all parts of body away from openings and moving parts.
- Do not use the robot vacuum to clean any burning substances.
- Make sure the robot vacuum is turned off and the power supply is unplugged before cleaning or performing maintenance.

- This robot vacuum is only intended to clean floors in a home environment. Do not use it outdoors such as on an open balcony or on a surface that is not a floor, like a sofa, or in a commercial or industrial setting.
- Do not use the robot vacuum in an area suspended above ground level, such as a loft, open balcony, or on top of furniture, unless a protective barrier is present.
- Do not use the robot vacuum at an ambient temperature above 35°C or below 0°C or on a floor with liquids or sticky substances.
- Pick up any cables from the floor before using the robot vacuum to prevent it from dragging them while cleaning.
- Pick up any fragile or loose items from the floor, such as vases or plastic bags, to prevent the robot vacuum from being obstructed or bumping into them and causing damage.
- Do not place children, pets, or any item on top of the robot vacuum while it is stationary or moving.
- Do not use the mopping function on the carpet.
- Do not allow the robot vacuum to pick up hard or sharp objects such as building materials, glass, or nails.
- Do not spray any liquid into the robot vacuum. Make sure the 2-in-1 dust compartment with water tank is thoroughly dry before its reinstalling.

- Do not place the robot vacuum upside down.
- Only use this product as directed in the user manual. Users are responsible for any loss or damage arising from improper use of this product.
- For detailed e-manual, please go to www.mi.com/global/service/userguide



Batteries and Charging

- **WARNING:** Do not use any third-party battery, charging dock.
- **WARNING:** Only use the supply unit provided with this appliance.
- **WARNING:** For the purposes of recharging the battery, only use the detachable supply unit provided with this appliance.
- Use only with <BLJ15W200060P-VA> supply unit.
- Do not attempt to disassemble, repair, or modify the battery or charging dock on your own.
- Disconnect the robot vacuum from power immediately if the battery leaks. If you come into physical contact with any substance that may leak out of the battery, rinse the contact area with plenty of water and seek medical attention immediately.
- Do not expose the appliance or battery to excessive temperatures.
- Be aware of the risk of terminals of the battery-operated appliance or battery being short-circuited by metal objects.

- Do not place the charging dock near a heat source.
- Do not use a wet cloth or wet hands to wipe or clean the dock's charging contacts.
- If the robot vacuum will not be used for an extended period, fully charge it, then turn it off and store in a cool, dry place. Recharge the robot vacuum at least once every 3 months to avoid over-discharging the battery.
- The lithium-ion battery pack contains substances that are hazardous to the environment. Before disposing of the robot vacuum, please first remove the battery pack, then discard, or recycle it in accordance with local laws and regulations of the country or region it is used in.
- The battery must be removed from the appliance before it is scrapped.
- The appliance must be disconnected from the supply mains when removing the battery.
- The battery is to be disposed of safely.
- When removing the batteries from the product, it is better to use up the batteries and make sure your product is disconnected from power.
 - 1). Uninstall the screw on the bottom, then remove the cover.
 - 2). Unplug the battery connector, then remove the batteries. Do not damage the battery case to avoid any risk of injuries.
 - 3). Return the batteries to a professional recycling organization.

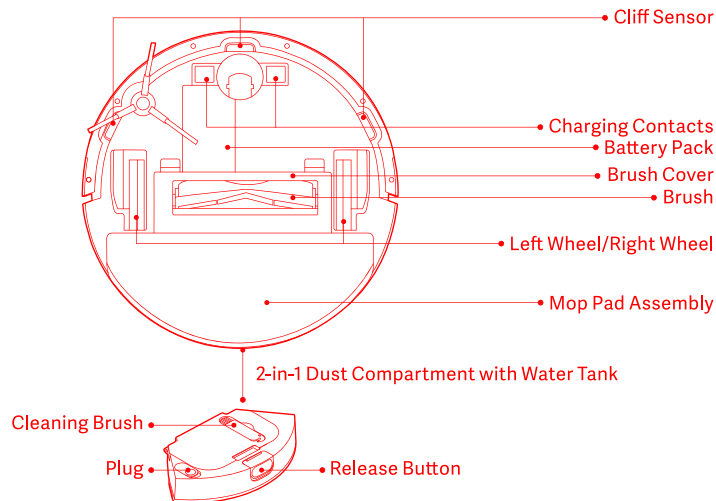
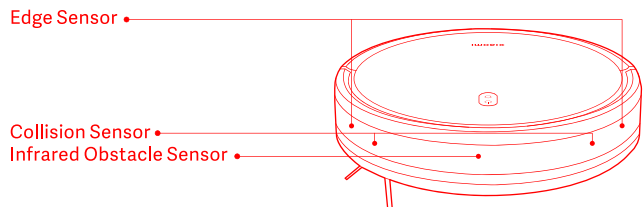
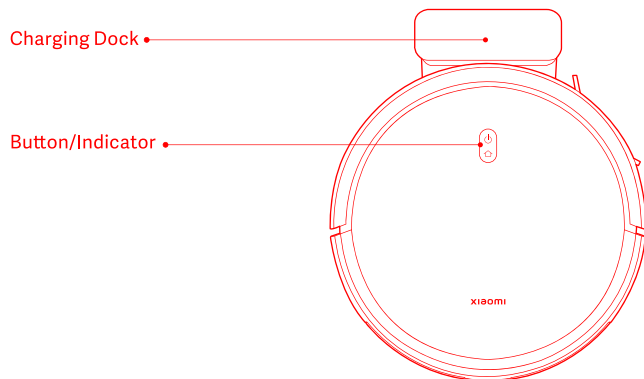
Product Overview



-  Press and hold for three seconds to turn on or off
-  Press to start or pause cleaning
-  Press to return to charge or stop docking

Indicator Status Descriptions

| | |
|------------------|---|
| White | Turned on/Working normally/Charging completed/Standby |
| Breathing white | Charging (battery level \geq 20%)/Turning on |
| Blinking white | Returning to charge/Updating firmware/Connecting to the network |
| Off | Turned off/In sleep |
| Yellow | Wi-Fi disconnected |
| Blinking yellow | Resetting Wi-Fi/Error |
| Breathing yellow | Charging (battery level $<$ 20%) |

Before Use

Removal and Installation

- Please remove the protective strips from both sides of the robot vacuum.
- Take out the side brush, and install it onto the position as indicated in the figure. The side brush is properly installed when you hear a "click".

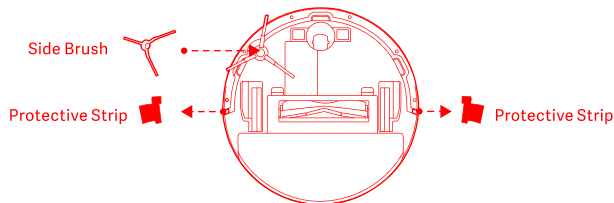

Charging

Remove the protective film from the charging dock. Place the charging dock against a wall and connect it to the power. Then place the robot vacuum onto the charging dock to charge.

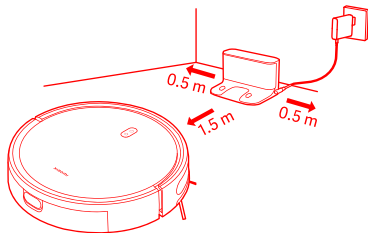

CAUTIONS:

- Do not place the charging dock in an area with direct sunlight.
- Please ensure that no items are placed within 0.5 m on the left and right sides and within 1.5 m in front of the charging dock.
- It is recommended to fully charge the robot vacuum before using it for the first time to maintain its optimal battery performance and maximize battery life.
- The robot vacuum will turn on automatically when it is on the charging dock, and cannot be turned off while charging.

Connecting with the Mi Home/Xiaomi Home App

This product works with the Mi Home/Xiaomi Home app*. Use the Mi Home/Xiaomi Home app to control your device, and to interact with other smart home devices.

Scan the QR code to download and install the app. You will be directed to the connection setup page if the app is installed already. Or search for "Mi Home/Xiaomi Home" in the app store to download and install it.



5E71B7F5



Open the Mi Home/Xiaomi Home app, tap "+" on the upper right, and then follow the instructions to add your device.

* The app is referred to as Xiaomi Home app in Europe (except for Russia). The name of the app displayed on your device should be taken as the default.



Notes:

- The version of the app might have been updated, please follow the instructions based on the current app version.
- If the robot vacuum's QR code cannot be scanned, you can search for its name to add it.
- When connecting the robot vacuum to the Mi Home/Xiaomi Home app using an iOS device, follow the instructions in the app to connect to the robot vacuum's hotspot "xiaomi-vacuum-b112bk_mibtxxxx".

Resetting Wi-Fi

While the robot vacuum is turned on, press and hold the buttons  and  for seven seconds. The Wi-Fi is successfully reset when you hear a voice prompt.

Resetting System

Press and hold the button  for five seconds until you hear a "beep", and then press and hold the button  for five seconds again until you hear the voice prompt. The robot vacuum then restarts, and settings like scheduled cleaning and Wi-Fi are restored to factory default.

How to Use

Start Vacuuming & Mopping

1. Press and hold the release button to remove the 2-in-1 dust compartment with water tank. Open the plug, fill the tank with clean water, and then refasten the plug. Install the 2-in-1 dust compartment with water tank onto the robot vacuum until it firmly clicks into place.

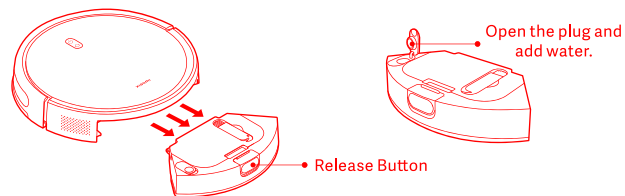

CAUTIONS:

- Please remove the 2-in-1 dust compartment with water tank before adding water. Do not add liquids such as hot water, detergent, or disinfectant to prevent damaging the robot vacuum.
- Due to production testing, the 2-in-1 dust compartment with water tank may have water stains, which is normal.

2. Before using the vacuuming & mopping function, dampen the mop pad and wring it out and then install it onto the mop pad holder. Install the mop pad holder to the 2-in-1 dust compartment with water tank, as illustrated.

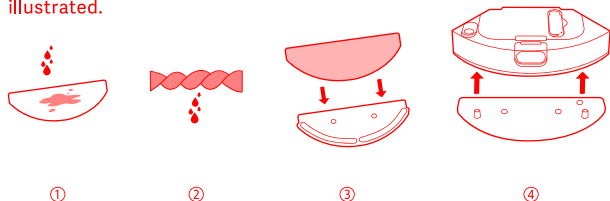

3. Install the 2-in-1 dust compartment with water tank into the robot vacuum. Press the button  to start vacuuming and mopping.

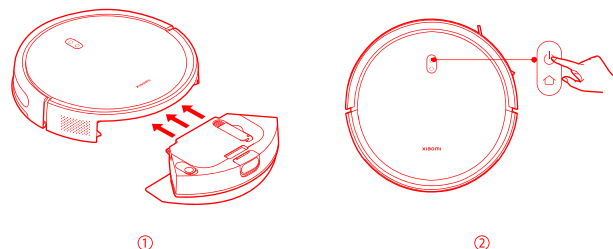

- CAUTION:** Remove the 2-in-1 dust compartment with water tank and pour out the leftover water in a timely manner after a mopping task has been completed. Then clean and dry the mop pad to prevent odor and mildew.

- If only vacuuming function is needed, please remove the mop pad holder.

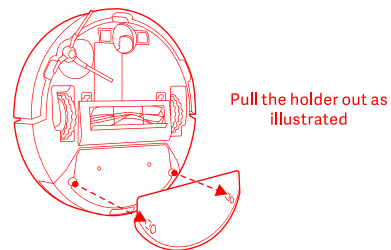

Pausing



When the robot vacuum is running, press any button to pause. Press the button  to resume cleaning.

Note: The robot vacuum will enter sleep mode after being paused or in standby mode for five minutes. Press any button to wake it up.

Adding Water or Cleaning the Mop Pad

When the robot vacuum is working, pause it first then remove the 2-in-1 dust compartment with water tank to add water or clean the mop pad. Then reinstall the 2-in-1 dust compartment with water tank and press the button  to resume the task.

Docking & Charging

When the robot vacuum is working, press the button  to pause the task, and press the button  again to send the robot vacuum to return to the dock to charge.

When the robot vacuum is in standby mode and not connected to the charging dock, press the button  to send the robot vacuum to return to the dock to charge. When a task is complete or the battery is too low, the robot vacuum will automatically return to the dock to charge.

DND Mode

In the do not disturb (DND) mode, the robot vacuum does not perform scheduled cleanups, and the indicator turns off after one minute of charging. The DND mode can be enabled or disabled in the app.

Note: For more functions, please go to the app.

Note: When using the robot vacuum for the first time, it is recommended to follow the robot vacuum and remove any obstacles on the ground. If the robot vacuum may get stuck or scratch the surface of the furniture in some areas, you can set physical barriers to prevent the robot vacuum from entering those areas.

Care & Maintenance

Brush and Side Brush

1. Remove the side brush.
2. Remove the brush cover, take out the brush, and pull out the brush bearing.
3. Use the cleaning brush to clean.

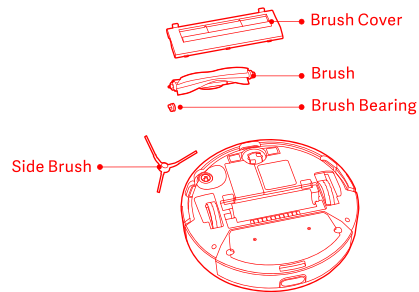

Cleaning the Brush

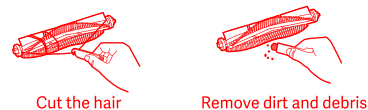

Notes:

- For cleaning and maintaining the 2-in-1 dust compartment with water tank & mop pad assembly, please refer to the labels on the tank and mop pad holder.
- It is recommended to clean sensors and charging contacts every three months with a soft cloth.
- Please refer to the table for accessory replacements to ensure the optimal cleaning effect.

| Components | Maintenance Frequency | Replacement Frequency |
|-------------|-----------------------|---------------------------------|
| Side brush | Every two weeks | Every 3-6 months |
| Brush | Weekly | Every 6-12 months |
| Filter | Weekly | Every 3-6 months |
| Brush cover | / | Every 3-6 months (or upon worn) |
| Mop pad | After each use | Every 3-6 months (or upon worn) |

Specifications

Robot Vacuum

| | |
|-----------------------|--|
| Name | Robotic Vacuum Cleaner |
| Model | B112 |
| Rated Voltage | 14.4 V \equiv |
| Rated Power | 35 W |
| Charging Voltage | 20 V \equiv |
| Item Dimensions | ϕ 325 × 80 mm |
| Battery Capacity | 2500 mAh (rated capacity) 2600 mAh (nominal capacity) |
| Net Weight | 3.2 kg |
| Wireless Connectivity | Wi-Fi IEEE 802.11b/g/n 2.4 GHz Bluetooth 4.2 |
| Operation Frequency | 2412–2472 MHz |
| Maximum Output Power | < 20 dBm |

Under normal use of condition, this equipment should be kept a separation distance of at least 20 cm between the antenna and the body of the user.

Charging Dock

| | |
|-----------------|---------------------|
| Model | CDZB112 |
| Rated Input | 20 V \equiv 0.6 A |
| Rated Output | 20 V \equiv 0.6 A |
| Item Dimensions | 146 × 122 × 87.5 mm |

Power Supply

| | |
|------------------------------|---|
| Manufacturer | Zhongshan Baolijin Electronic Co., Ltd. |
| Model | BLJ15W200060P-VA |
| Input | 100–240 V~ 50/60 Hz 0.5 A |
| Output | 20.0 V \equiv 0.6 A 12.0 W |
| Average Active Efficiency | 82.96% |
| Efficiency at Low Load (10%) | 60% |
| No-load Power Consumption | 0.10 W |

Note: Illustrations of product, accessories, and user interface in the user manual are for reference purposes only. Actual product and functions may vary due to product enhancements.

Regulatory Compliance Information

EU Declaration of Conformity



Hereby, Xiaomi Communications Co., Ltd. declares that the radio equipment type B112 is in compliance with Directive 2014/53/EU. The full text of the EU declaration of conformity is available at the following internet address:
<http://www.mi.com/global/service/support/declaration.html>

WEEE Disposal and Recycling Information



All products bearing this symbol are waste electrical and electronic equipment (WEEE as in directive 2012/19/EU) which should not be mixed with unsorted household waste. Instead, you should protect human health and the environment by handing over your waste equipment to a designated collection point for the recycling of waste electrical and electronic equipment, appointed by the government or local authorities. Correct disposal and recycling will help prevent potential negative consequences to the environment and human health. Please contact the installer or local authorities for more information about the location as well as terms and conditions of such collection points.

WARRANTY NOTICE

THIS WARRANTY GIVES YOU SPECIFIC RIGHTS, AND YOU MAY HAVE OTHER RIGHTS CONVEYED BY LAWS OF YOUR COUNTRY, PROVINCE OR STATE. INDEED, IN SOME COUNTRIES, PROVINCES OR STATES, CONSUMER LAW MAY IMPOSE A MINIMUM WARRANTY PERIOD. OTHER THAN AS PERMITTED BY LAW, XIAOMI DOES NOT EXCLUDE, LIMIT OR SUSPEND OTHER RIGHTS YOU MAY HAVE. FOR A FULL UNDERSTANDING OF YOUR RIGHTS WE INVITE YOU TO CONSULT THE LAWS OF YOUR COUNTRY, PROVINCE OR STATE.

1. LIMITED PRODUCT WARRANTY

XIAOMI warrants that the Products are free from defects in materials and workmanship under normal use and use in accordance with the respective Product user manual, during the Warranty Period.

The duration and conditions related to the legal warranties are provided by respective local laws. For more information about the consumer warranty benefits, please refer to Xiaomi's official website
<https://www.mi.com/global/support/warranty>

Xiaomi warrants to the original purchaser that its Xiaomi Product will be free from defects in materials and workmanship under normal use in the period mentioned above.

Xiaomi does not guarantee that the operation of the Product will be uninterrupted or error free.

Xiaomi is not liable for damages arising from non-compliance with the instructions related to the use of the Product.

2. REMEDIES

If a hardware defect is found and a valid claim is received by Xiaomi within the Warranty Period, Xiaomi will either (1) repair the product at no charge, (2) replace the product, or (3) refund the Product, excluding potential shipping costs.

3. HOW TO OBTAIN WARRANTY SERVICE

To obtain warranty service, you must deliver the Product, in its original packaging or similar packaging providing an equal degree of Product protection, to the address specified by Xiaomi. Except to the extent prohibited by applicable law, Xiaomi may

require you to present proofs or proof of purchase and / or comply with registration requirements before receiving warranty service.

4. EXCLUSIONS AND LIMITATIONS

Unless otherwise stipulated by Xiaomi, this Limited Warranty applies only to the Product manufactured by or for Xiaomi and identifiable by the trademarks, trade name or "Xiaomi" or "Mi" logo.

The Limited Warranty does not apply to any (a) Damage due to acts of nature or God, for example, lightning strikes, tornadoes, flood, fire, earthquake or other external causes; (b) Negligence; (c) Commercial use; (d) Alterations or modifications to any part of the Product; (e) Damage caused by use with non-Xiaomi products; (f) Damage caused by accident, abuse or misuse; (g) Damage caused by operating the Product outside the permitted or intended uses described by Xiaomi or with improper voltage or power supply; or (h) Damage caused by service (including upgrades and expansions) performed by anyone who is not a representative of Xiaomi.

It is your responsibility to backup any data, software, or other materials you may have stored or preserved on the product. It is likely that the data, software or other materials in the equipment will be lost or reformatted during the service process, Xiaomi is not responsible for such damage or loss.

No Xiaomi reseller, agent, or employee is authorized to make any modification, extension, or addition to this Limited Warranty. If any term is held to be illegal or unenforceable, the legality or enforceability of the remaining terms shall not be affected or impaired.

Except as prohibited by laws or otherwise promised by Xiaomi, the after-sales services shall be limited to the country or region of the original purchase. Products which were not duly imported and/or were not duly manufactured by Xiaomi and/or were not duly acquired from Xiaomi or a Xiaomi's official seller are not covered by the present warranties. As per applicable law you may benefit from warranties from the non-official retailer who sold the product. Therefore, Xiaomi invites you to contact the retailer from whom you purchased the product. The present warranties do not apply in Hong Kong and Taiwan.

5. IMPLIED WARRANTIES

Except to the extent prohibited by applicable law, all implied warranties (including

warranties of merchantability and fitness for a particular purpose) will have a limited duration up to a maximum duration of this limited warranty. Some jurisdictions do not allow limitations on the duration of an implied warranty, so the above limitation will not be applied in these cases.

6. DAMAGE LIMITATION

Except to the extent prohibited by applicable law, Xiaomi shall not be liable for any damages caused by accidents, indirect, special or consequential damages, including but not limited to loss of profits, revenue or data, damages resulting from any breach of express or implied warranty or condition, or under any other legal theory, even if Xiaomi has been informed of the possibility of such damages. Some jurisdictions do not allow the exclusion or limitation of special, indirect, or consequential damages, so the above limitation or exclusion may not apply to you.

7. XIAOMI CONTACTS

For customers, please visit the website:
<https://www.mi.com/global/support/warranty>

The contact person for the after-sale service may be any person in Xiaomi's authorized service network, Xiaomi's authorized distributors or the final vendor who sold the products to you. If in doubt please contact the relevant person as Xiaomi may identify.

For further information, please go to www.mi.com
Manufactured by: Xiaomi Communications Co., Ltd.
Address: #019, 9th Floor, Building 6, 33 Xi'erqi Middle Road, Haidian District,
Beijing, China, 100085



For further details, please scan the QR code to obtain the e-manual.

Importer:
Beryko s.r.o.
Pod Vinicemi 931/2, 301 00 Plzeň
www.berko.cz

